

MX4S tunable WHITE 4" Continuous – Surface

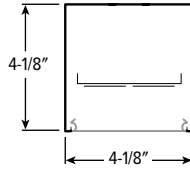
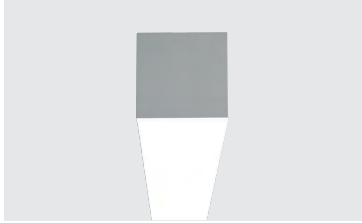

CATALOG #: _____

TYPE: _____

PROJECT: _____

FEATURES

- Tunable white from 3000K to 5000K CCT, minimum 80 CRI
- Create elegant spaces with a seamless, continuous row of illumination
- Flat and proud lenses give designers a variety of looks
- Maximize energy savings with efficacies as high as 123 lm/W
- Linear extrusion contains snap-in light rails for ease of installation and maintenance
- Versatile MX4 system includes recessed, surface, suspended and in-wall mounting, see hew.com
- Corner configurations available, see Product Builder at hew.com/product-builder
- Diffuse acrylic lens provides uniform illumination for visual comfort
- Made Right Here® in the USA

SPECIFICATIONS

- HOUSING – Extruded aluminum with die-cast end plates.
- SHIELDING – Extruded, flat, diffuse acrylic lens.
- FINISH – Textured matte white polyester TGIC powder coat bonded to phosphate-free, multi-stage pretreated metal. All parts painted after fabrication to facilitate installation, increase efficiency, and inhibit corrosion.
- ELECTRICAL – High quality mid-power LED board. L70 > 60,000 hours per IES TM-21. Tunable White products use LEDs of multiple CCTs and may produce a perceptibly different shade of white from single-CCT products at the same CCT. All CCTs are within 3 MacAdam ellipses.
- MOUNTING – Surface.
- LISTINGS – cCSAus certified as luminaire suitable for dry or damp locations.
- WARRANTY – 5-year limited warranty, see hew.com/warranty.

ORDERING EXAMPLE: MX4S - 12'00 - L8/8TW - F - OPTIONS - CONTROL - DALI - UNV

SERIES LENGTH

MX4S Lengths specified in feet and inches using 4" increments, 2' minimum.
Example: 12'00 = 12'-0"

Product Builder

Easily build shapes & simplify ordering with the Williams Linear Product Builder at hew.com/product-builder ^[1]



LUMENS ^[2]	COLOR	SHIELDING	OPTIONS ^[3]
L8 800lm	8TW Tunable white (80 CRI, 3000K-5000K)	F Flat, diffuse acrylic P Proud, diffuse acrylic with 5/16" drop ^[4]	EM/7W 7-watt emergency battery ^[5] EM/7WRM Remote mount 7-watt emergency battery EM/10W 10-watt emergency battery ^[6] EM/10WRM Remote mount 10-watt emergency battery ASY Asymmetric distribution ^[7] (L_) Additional lower lumen packages available ^[8] Example: 600 lumens = MX4S-12'00-L8/8TW-(L6)

CONTROL ^[9]	DRIVER ^[10]	VOLTAGE
– None	DALI Driver prewired for DALI applications	120 120V
WS FS-305-L6-PP-120/277 Wattstopper PIR motion and daylight hold off sensor with power pack, 120/277V	DIM (1) 0-10V signal to control dimming (1) 0-10V signal to control CCT	277 277V UNV 120-277V
WS LMFS-601-PP-120/277 Wattstopper PIR motion and daylight sensor with power pack, 120/277V	DMX Driver prewired for DMX applications	
SS SFR-7-120/277 Sensor Switch PIR motion sensor, 120/277V	PSQ Lutron T-Series 2-channel tunable white 1%	

NOTES

- ¹ See page 5 for CORNER DETAILS.
- ² Lumens per foot based on 4000K CCT and F shielding. Actual lumens may vary ±5%. See page 2 for FIXTURE PERFORMANCE DATA. Additional lumen packages available, see Options.
- ³ See page 4 for FINISH OPTIONS. Custom colors available upon request. See Technical Info for [Power Entry](#) details.
- ⁴ See page 4 for SHIELDING DETAILS. Not available with corner configurations.
- ⁵ Not available with fixtures less than 4'.
- ⁶ Not available with fixtures less than 4'.
- ⁷ Available with F shielding only. Creates uneven lens illumination. See page 4 for CROSS SECTIONS.
- ⁸ (L4) lumen package minimum. Specify in increments of 100 nominal lumens. Option must be specified with next higher lumen package.
- ⁹ Reduces portion of lit fixture, consult factory. See page 3 for CONTROL DETAILS.
- ¹⁰ See page 4 for DRIVER DETAILS.



MX4S tunable WHITE 4" Continuous – Surface

FIXTURE PERFORMANCE DATA

PER FOOT		
DELIVERED LUMENS	WATTAGE	EFFICACY (lm/W)
821	6.7	123

- Photometrics tested in accordance with IESNA LM-79. Results shown are based on 25°C ambient temperature.
- Wattage shown is average for 120V through 277V input.
- Results based on 4000K, 80 CRI, actual lumens may vary +/-5%
- Use multiplier table to calculate additional options.

MULTIPLIER TABLE

CCT	CONVERSION FACTOR	
	LUMENS	WATTAGE
3000K	0.95	1.04
3500K	0.98	1.02
4000K	1.00	1.00
5000K	0.96	1.04

ASY OPTION	
WATTAGE	EFFICACY (lm/W)
1.03	0.97

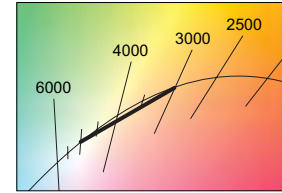

PHOTOMETRY

MX4S-4'00-L8/8TW-F-DALI Total Luminaire Output: 3284 lumens; 26.8 Watts | Efficacy: 123 lm/W | 80 CRI; 4000K CCT

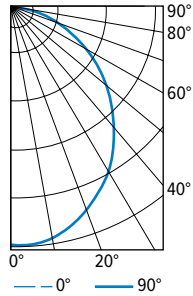

CANDLEPOWER DISTRIBUTION	VERTICAL ANGLE	HORIZONTAL ANGLE			ZONAL LUMENS
		0°	45°	90°	
	0	1297	1297	1297	
	5	1324	1287	1273	122
	15	1280	1228	1206	347
	25	1145	1109	1083	510
	35	992	944	927	595
	45	805	768	740	595
	55	602	573	538	511
	65	392	369	353	367
	75	185	177	176	192
	85	29	36	33	45
	90	0	0	0	

LUMEN SUMMARY	ZONE	LUMENS	% FIXTURE
0 - 40	1574	48	
0 - 60	2680	82	
0 - 90	3284	100	
0 - 180	3284	100	

MX4S-4'00-L8/8TW-F-ASY Total Luminaire Output: 3089 lumens; 26.8 Watts | Efficacy: 115 lm/W | 80 CRI; 4000K CCT

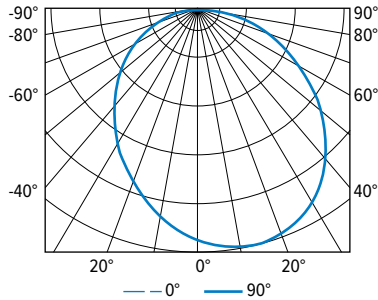

CANDLEPOWER DISTRIBUTION	VERTICAL ANGLE	HORIZONTAL ANGLE					ZONAL LUMENS
		0°	45°	90°	135°	180°	
	0	1114	1114	1114	1114	1114	
	5	1110	1135	1148	1135	1110	105
	15	1064	1145	1179	1145	1064	300
	25	977	1097	1147	1097	977	452
	35	851	989	1046	989	851	537
	45	702	839	891	839	702	547
	55	541	661	705	661	541	490
	65	371	465	499	465	371	374
	75	196	266	290	266	196	219
	85	48	83	96	83	48	65
	90	2	12	18	12	2	

LUMEN SUMMARY	ZONE	LUMENS	% FIXTURE
0 - 40	1394	45	
0 - 60	2431	79	
0 - 90	3089	100	
0 - 180	3089	100	



MX4S tunable WHITE 4" Continuous – Surface

CONTROL DETAILS

SENSOR PLACEMENT

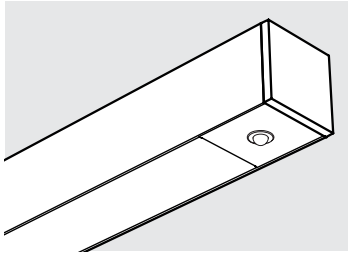

WS FS-305-L6-PP-120/277

SPECIFICATIONS	
TYPE	PIR Motion + Daylight Hold Off
MOUNTING HEIGHT	8'
LENS	Indoor, non-wet location use
DETECTION ANGLE	360°
TEMPERATURE RANGE	-40° to 55°C
RELATIVE HUMIDITY	5% to 95%, non-condensing
COMMISSIONING	Dials under lens
MANUFACTURER	Wattstopper

SENSOR COVERAGE PATTERNS

8' height: ø20' coverage

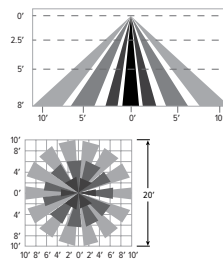

WS LMFS-601-PP-120/277

SPECIFICATIONS	
TYPE	PIR Motion + Daylight
MOUNTING HEIGHT	8' – 12'
LENS	Up to 300 sq/ft coverage
DETECTION ANGLE	360°
TEMPERATURE RANGE	0° to 50°C
RELATIVE HUMIDITY	0 to 90%, non-condensing
COMMISSIONING	App (iOS or Android)
MANUFACTURER	Wattstopper

SENSOR COVERAGE PATTERNS

8' height: ø20' coverage

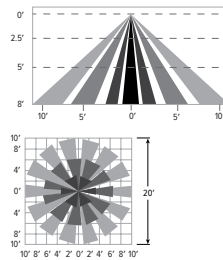

SS SFR-7-120/277

SPECIFICATIONS	
TYPE	PIR Motion
MOUNTING HEIGHT	8' – 20'
DETECTION ANGLE	360°
TEMPERATURE RANGE	-10° to 60°C
RELATIVE HUMIDITY	0 to 90%, non-condensing
COMMISSIONING	Single push button on sensor
MANUFACTURER	Sensor Switch

SENSOR COVERAGE PATTERNS

9' height: ø36' coverage 15' height: ø60' coverage

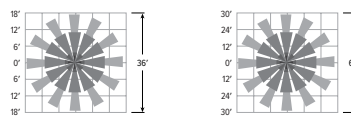

MX4S tunable WHITE

4" Continuous – Surface

DRIVER DETAILS

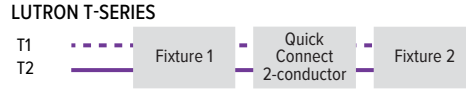
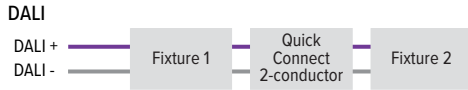
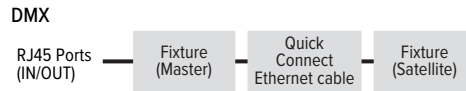
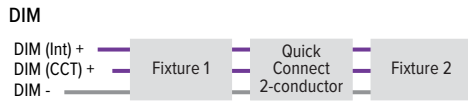

FIXTURE DETAILS

BACK VIEW

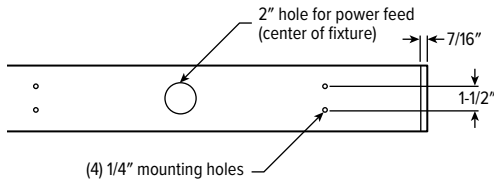

SHIELDING DETAILS

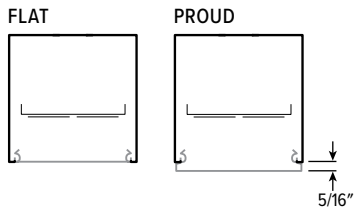

CROSS SECTIONS

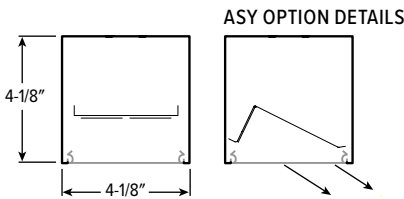

FINISH OPTIONS

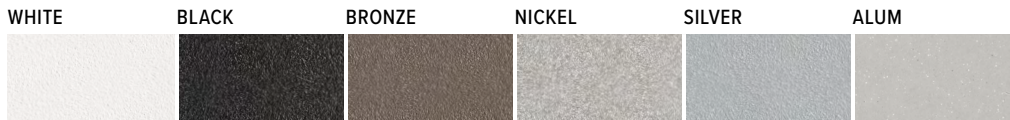

For custom color, please specify RAL code or a manufacturer code with description. All custom colors other than RAL require two sample swatches, minimum 1" square.



MX4S tunable WHITE 4" Continuous – Surface

CORNER DETAILS

BACK VIEW

LEFT

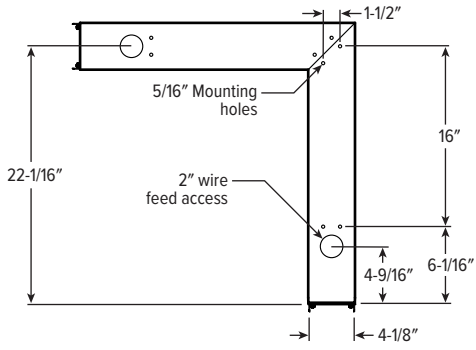

Note: Corner orientation determined in field.
Feeder corner end cap shipped separately.

