

CATALOG #: _____

TYPE: _____

PROJECT: _____

NEW CONSTRUCTION AND REMODEL

FEATURES

- Create scalable, highly functioning smart buildings with Platformatics Power over Ethernet controls

SPECIFICATIONS

- **HOUSING** – Die-cast aluminum trim housing with forged aluminum heat sink. Swing-out mounting arms field adjust for ceiling thickness from 1/2" – 2-3/8".
- **OPEN REFLECTOR** – Low-iridescent anodized aluminum. Clear semi-specular finish standard.
- **LENSED TRIM** – Die-cast aluminum frame with micro-prismatic, acrylic lens. Diffuse acrylic lens standard with A Trim Type.
- **ELECTRICAL** – High-performance Class 2 C.O.B. LED array. Modular quick-connect plug for easy field-connection of LED light assembly to node. Reported L70>55,000 hours. Reported L90>55,000 hours. Estimated L70 = 200,000 hours. Low-voltage DC fixture, to be fed by Class 2 power supply. Tunable White products use LEDs of multiple CCTs and may produce a perceptibly different shade of white from single-CCT products at the same CCT. All CCTs are within 3 MacAdam ellipses.
- **MOUNTING** – Recessed. 20 ga. galvanized steel mounting pan for new construction or IC-rated enclosure. Minimum 12-1/2" O.C. marked spacing required for P15 static white (S Distribution only), P20 and P23 static white, P12 and P15 tunable white lumen packages when specified with R Mounting Type. Nodes cannot be mounted above hard ceilings
- **LISTINGS** –
 - cCSAus conforms to UL STD 1598; Certified to CAN/CSA STD C22.2 No. 250.0 for damp locations. LED light assembly conforms to UL 2108 for remote installation.
 - Suitable for wet location under covered ceiling when specified with WET/CC or TD options.
 - IC-rated for direct contact with insulation when specified with I Mounting Type.
 - City of Chicago Environmental Air approved when specified with CP option.
 - Complies with ASTM-E283 when specified with ATH option.
 - RoHS compliant.
- **WARRANTY** – 5-year limited warranty, see hew.com/warranty.

SYSTEM REQUIREMENTS

- PoE-ready luminaires are connected to building power systems through network integration and require other components for complete PoE lighting system.
- For additional PoE info, see hew.com/poe.
- Consult factory for design support.



ORDERING EXAMPLE: 2DR - P20/835 - OPTIONS - POE PR - OW - OF - CS - TRIM OPTIONS - N - F1

HOUSING

SERIES	LUMENS ^[1]	CRI	CCT	OPTIONS	CONTROL ^[2]
2DR	P5 500lm	8 80 ^[3]	27 2700K	ATH Airtight construction	POE PR Power over Ethernet, Platformatics-ready
	P7 700lm	9 90 ^[4]	30 3000K	CP Chicago plenum (CCEA) ^[6]	
	P9 900lm		35 3500K		
	P12 1,200lm		40 4000K		
	P15 1,500lm		50 5000K		
	P20 2,000lm		TW Tunable white (90 CRI, 2700K-5000K) ^[5]		
	P23 2,300lm				

TRIM^[7]

TRIM TYPE	DISTRIBUTION ^[8]	FLANGE TYPE	REFLECTOR FINISH	TRIM OPTIONS
O Open reflector	W 70° Wide	OF 1/2" standard flange	Open trim types	MWT Textured white trim flange ^[15]
L Flush lens	M 40° Medium	ZF Zero-flange mud-in ^[13]	CS Clear semi-specular anodize	AD Diffuse acrylic lens ^[16]
R Regressed lens	N 15° Narrow ^[10]		SG Satin-glow anodize	PD Diffuse 1/8" polycarbonate lens ^[17]
A Angled lens ^[9]	S 8° Narrow spot ^[11]		GD Gold anodize	TD Diffuse polycarbonate lens media at top of open reflector ^[18]
	WW Wall wash ^[12]		CG Champagne gold anodize	WET/CC Wet location, covered ceiling listed ^[19]
			PW Pewter anodize	AM Anti-microbial ^[20]
			SPC Clear specular anodize	
			RG Rose gold anodize	
			WH White texture powder coat	
			BL Black texture powder coat	
			Lens trim types	
			CS Clear semi-specular powder coat	
			WH White texture powder coat	
			BL Black texture powder coat	
			MB Black texture splay with white flange ^[14]	

MOUNTING

MOUNTING TYPE^[21]

- N Open pan for new construction
- I IC-rated enclosure for new construction^[23]
- R Remodel kit^[24]

MOUNTING HARDWARE^[22]

- F1 Integral 2-position fixed pan bracket, universal bar hanger included^[25]
- BA1 Adjustable butterfly pan bracket, bar hanger not included^[26]
- CA1 Adjustable caterpillar pan bracket, universal bar hanger included^[27]

NOTES

- Lumen output based on O trim type, W distribution and CS finish, 3500K/80 CRI for single CCT and 4000K/90 CRI for TW. Actual lumens may vary +/-5%, see page 2 for FIXTURE PERFORMANCE DATA.
- See page 5 for NODE CONNECTION DETAILS. For additional PoE info, see hew.com/poe.
- Not available with tunable white.
- Extended lead times may apply for single CCT. Consult factory for availability.
- P15 lumen package max with W, M, and WW Distributions. P12 lumen package max with N Distribution. Not available with S Distribution.
- I Mounting Type required.
- Trim ships separately.
- Beam angle based on static white, O Trim Type and CS Reflector Finish. Trim Type affects beam angle. See page 2 for FIXTURE PERFORMANCE DATA.
- Available with WW Distribution only.
- P20 static white and P12 tunable white lumen packages max for N and R Mounting. P12 static white and P7 tunable white lumen packages max for I Mounting when specified with L, R or A Trim Types.
- Static white only. P15 lumen package max for N and R Mounting. P12 lumen package max for I Mounting. Not available with 950 CRI/CCT.
- A Trim Type only.
- For use with mud-in plaster construction only, supplied with mud flange installation kit. See page 4 for TRIM TYPE DETAILS. Not available with O Trim Type or ATH Option.
- R Trim Type only. Not available with ZF Flange Type or MWT.
- Not available with ZF Flange Type or WH Reflector Finish.
- W distribution only. Not available with O Trim Type.
- W and WW distributions only. Not available with O Trim Type.

- O Trim Type only. WET/CC standard.
- Not available with PD trim option.
- WH and BL Reflector Finishes only.
- Mounting hardware required (N and I only), ordered separately, see MOUNTING HARDWARE ordering info. See page 5 for MOUNTING TYPE DETAILS.
- Additional mounting hardware options available. See page 5 for MOUNTING HARDWARE DETAILS.
- P15 static white and P9 tunable white lumen packages max.
- Also used in new construction sheetrock ceilings.
- N and I Mounting Types only. I Mounting requires external brackets.
- N Mounting Type only.
- N Mounting Type only.

FIXTURE PERFORMANCE DATA

STATIC WHITE (See page 3 for tunable white data)

DISTRIBUTION	WATTAGE	OPEN REFLECTOR TRIM TYPE		FLUSH LENS TRIM TYPE		REGRESSED LENS TRIM TYPE		ANGLED LENS TRIM TYPE		
		DELIVERED LUMENS	EFFICACY (lm/W)	DELIVERED LUMENS	EFFICACY (lm/W)	DELIVERED LUMENS	EFFICACY (lm/W)	DELIVERED LUMENS	EFFICACY (lm/W)	
P5	W	4.2	516	123	540	129	535	127	–	–
	M	4.2	499	119	532	127	509	121	–	–
	N	4.2	407	97	528	126	515	123	–	–
	S	5.4	452	84	583	108	562	104	–	–
	WW	4.2	–	–	–	–	–	–	366	87
P7	W	5.9	706	120	739	125	732	124	–	–
	M	5.9	682	116	728	123	697	118	–	–
	N	5.9	557	94	722	122	704	119	–	–
	S	7.6	587	77	813	107	784	103	–	–
	WW	5.9	–	–	–	–	–	–	501	85
P9	W	7.9	910	115	953	121	943	119	–	–
	M	7.9	879	111	938	119	898	114	–	–
	N	7.9	718	91	931	118	908	115	–	–
	S	11.1	807	73	1041	94	1004	90	–	–
	WW	7.9	–	–	–	–	–	–	645	63
P12	W	11.5	1267	110	1327	115	1313	114	–	–
	M	11.5	1224	106	1307	114	1250	109	–	–
	N	11.5	1000	87	1296	113	1264	110	–	–
	S	15.3	1000	65	1382	90	1332	87	–	–
	WW	11.5	–	–	–	–	–	–	898	78
P15	W	14.7	1571	107	1645	112	1628	111	–	–
	M	14.7	1518	103	1620	110	1550	105	–	–
	N	14.7	1240	84	1607	109	1567	107	–	–
	S	22.7	1325	58	1711	75	1650	73	–	–
	WW	14.7	–	–	–	–	–	–	1114	76
P20	W	20.6	2063	100	2160	105	2138	104	–	–
	M	20.6	1993	97	2127	103	2035	99	–	–
	N	20.6	1629	79	2110	102	2058	100	–	–
	S	–	–	–	–	–	–	–	–	–
	WW	20.6	–	–	–	–	–	–	1463	71
P23	W	23.7	2281	96	2388	101	2364	100	–	–
	M	23.7	2204	93	2352	99	2251	95	–	–
	N	23.7	1801	76	–	–	–	–	–	–
	S	–	–	–	–	–	–	–	–	–
	WW	23.7	–	–	–	–	–	–	1617	68

MULTIPLIER TABLES

	COLOR TEMPERATURE		
	CCT	LUMENS	
		STANDARD	TUNABLE WHITE
80 CRI	2700K	0.92	–
	3000K	0.98	–
	3500K	1.00	–
	4000K	1.01	–
	5000K	1.02	–
90 CRI	2700K	0.76	0.87
	3000K	0.79	0.96
	3500K	0.82	1.02
	4000K	0.84	1.00
	5000K	0.88	1.02

	REFLECTOR FINISH	
	CATALOG NUMBER	CONVERSION FACTOR
O TRIM	CS	1.00
	SG ¹	0.92
	GD	0.93
	CG	0.96
	PW	0.86
	SPC	1.02
	RG	0.88
	WH ¹	0.89
BL ¹	0.47	
R TRIM	WH	1.00
	CS	0.98
	BL	0.79

	TRIM OPTIONS	
	CATALOG NUMBER	CONVERSION FACTOR
AD	0.85	
PD	0.85	
TD	0.67	
WET/CC ²	0.85	

BEAM ANGLE

	TRIM TYPE		
	OPEN	FLUSH	REGRESSED
W	70°	50°	55°
M	40°	30°	30°
N	15°	20°	20°
S	8°	14°	14°

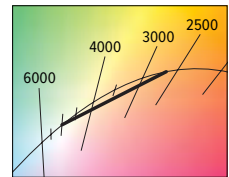

- Distribution will also be affected, consult factory.
- Use multiplier only when specified with O Trim Type.
 - Photometrics tested in accordance with IESNA LM-79. Results shown are based on 25°C ambient temperature.
 - Standard results based on 3500K/80 CRI and CS (O Trim Type) or WH (L, R and A Trim Types) Reflector Finish. Actual lumens may vary +/-5%.
 - Tunable white results based on 4000K/90CRI and CS (O Trim Type) or WH (L, R and A Trim Types) Reflector Finish. Actual lumens may vary +/-5%.
 - Wattage and efficacy data shown do not account for node losses.
 - Beam angle based on static white, O Trim Type and CS Reflector Finish.
 - Use multiplier tables to calculate additional options.



2DR PoE | tunable WHITE 2" Downlight – Round

TUNABLE WHITE (See page 2 for static white data)

DISTRIBUTION	WATTAGE	OPEN REFLECTOR TRIM TYPE		FLUSH LENS TRIM TYPE		REGRESSED LENS TRIM TYPE		ANGLED LENS TRIM TYPE		
		DELIVERED LUMENS	EFFICACY (lm/W)	DELIVERED LUMENS	EFFICACY (lm/W)	DELIVERED LUMENS	EFFICACY (lm/W)	DELIVERED LUMENS	EFFICACY (lm/W)	
P5	W	7.3	570	78	597	82	591	81	-	-
	M	7.3	575	79	614	84	587	80	-	-
	N	7.3	440	60	571	78	557	76	-	-
	S	-	-	-	-	-	-	-	-	-
	WW	7.3	-	-	-	-	-	-	404	55
P7	W	10.1	761	75	797	79	789	78	-	-
	M	10.1	768	76	819	81	784	78	-	-
	N	10.1	588	58	762	75	743	74	-	-
	S	-	-	-	-	-	-	-	-	-
	WW	10.1	-	-	-	-	-	-	540	53
P9	W	14.6	1062	73	1112	76	1101	75	-	-
	M	14.6	1071	73	1144	78	1094	75	-	-
	N	14.6	821	56	1063	73	1037	71	-	-
	S	-	-	-	-	-	-	-	-	-
	WW	14.6	-	-	-	-	-	-	753	52
P12	W	19.3	1306	68	1368	71	1353	70	-	-
	M	19.3	1318	68	1406	73	1346	70	-	-
	N	19.3	1009	52	1308	68	1275	66	-	-
	S	-	-	-	-	-	-	-	-	-
	WW	19.3	-	-	-	-	-	-	926	48
P15	W	23.7	1462	62	1531	65	1515	64	-	-
	M	23.7	1475	62	1574	66	1506	64	-	-
	N	23.7	1130	48	-	-	-	-	-	-
	S	-	-	-	-	-	-	-	-	-
	WW	23.7	-	-	-	-	-	-	1037	44
P20	W	-	-	-	-	-	-	-	-	-
	M	-	-	-	-	-	-	-	-	-
	N	-	-	-	-	-	-	-	-	-
	S	-	-	-	-	-	-	-	-	-
	WW	-	-	-	-	-	-	-	-	-
P23	W	-	-	-	-	-	-	-	-	-
	M	-	-	-	-	-	-	-	-	-
	N	-	-	-	-	-	-	-	-	-
	S	-	-	-	-	-	-	-	-	-
	WW	-	-	-	-	-	-	-	-	-

PHOTOMETRY

2DR-P15/835-POE PR-OW-OF-CS Total Luminaire Output: 1571 lumens; 14.7 Watts | Efficacy: 107 lm/W | 80 CRI; 3500K CCT

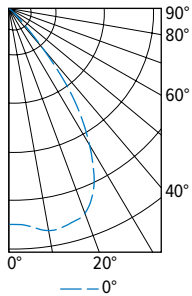

CANDLEPOWER DISTRIBUTION	VERTICAL ANGLE	HORIZONTAL ANGLE	ZONAL LUMENS
		0°	
	0	1274	
	5	1288	125
	15	1323	374
	25	1178	532
	35	690	415
	45	95	96
	55	22	21
	65	7	8
	75	1	2
	85	0	0
	90	0	0

LUMEN SUMMARY	ZONE	LUMENS	% FIXTURE
	0 - 40	1445	92
	0 - 60	1562	99
	0 - 90	1571	100
	0-180	1571	100



2DR PoE | tunable WHITE 2" Downlight – Round

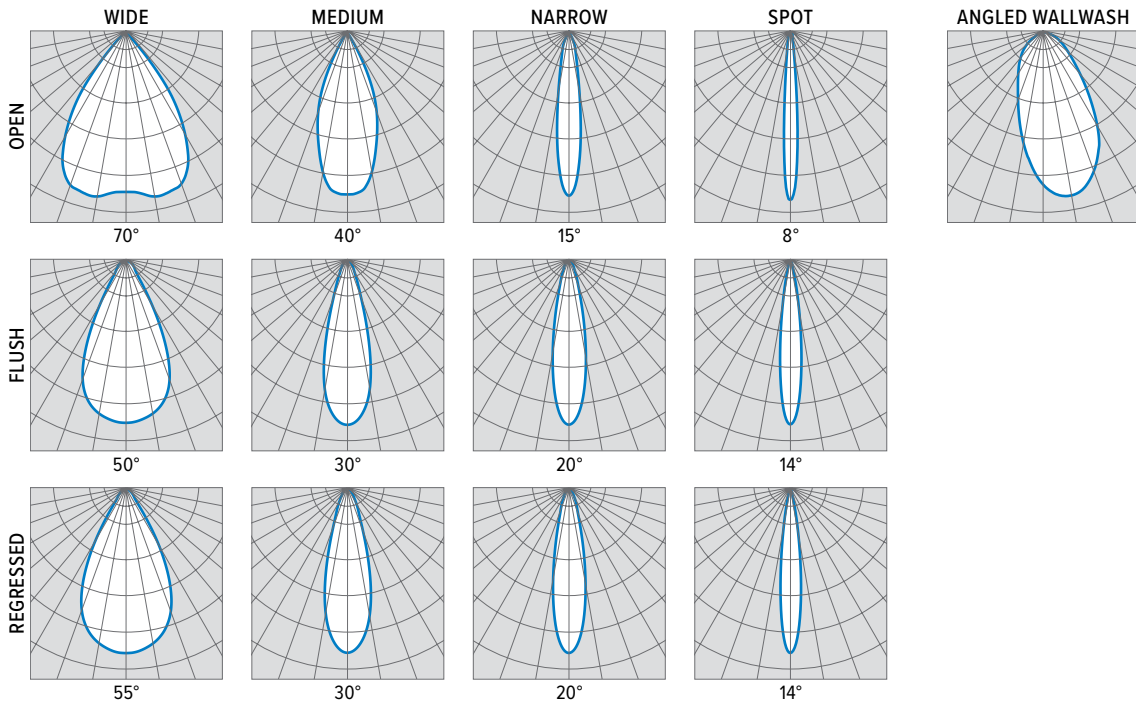

TRIM TYPE DETAILS

1/2" STANDARD FLANGE TYPE

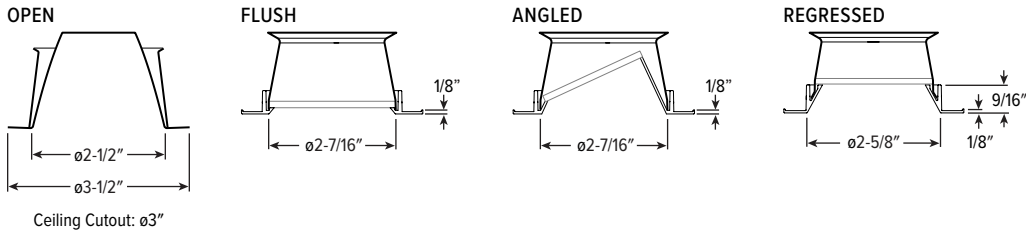

ZERO-FLANGE MUD-IN

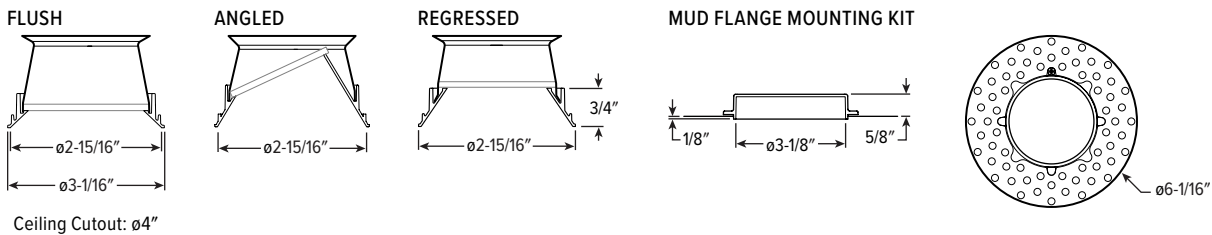

REFLECTOR FINISH DETAILS

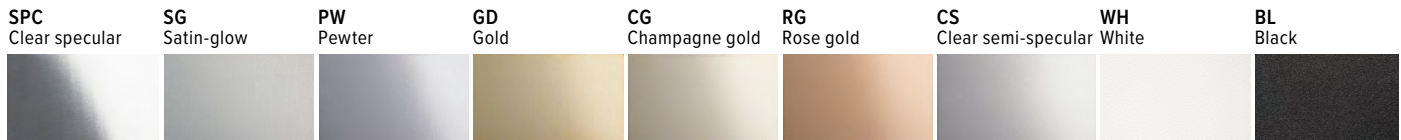

2DR PoE | tunable WHITE 2" Downlight – Round

MOUNTING TYPE DETAILS

NEW CONSTRUCTION

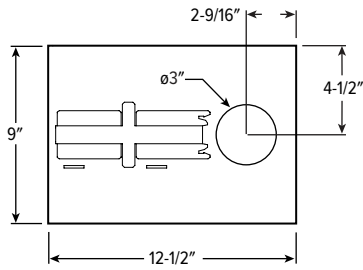

IC-RATED

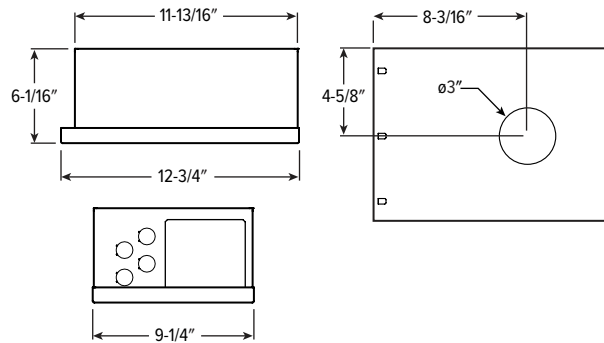

REMODEL

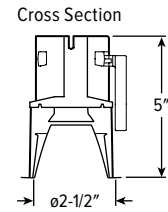

MOUNTING HARDWARE DETAILS

F1 Integral 2-position fixed pan bracket, universal bar hanger included

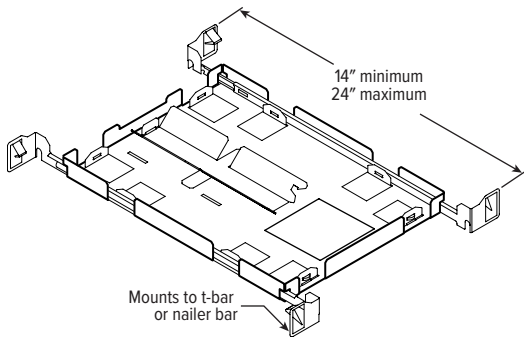

BA1 Adjustable butterfly pan bracket, bar hanger not included (N Mounting Type only)

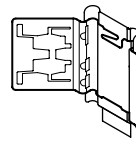

CA1 Adjustable caterpillar pan bracket, universal bar hanger included (N Mounting Type only)

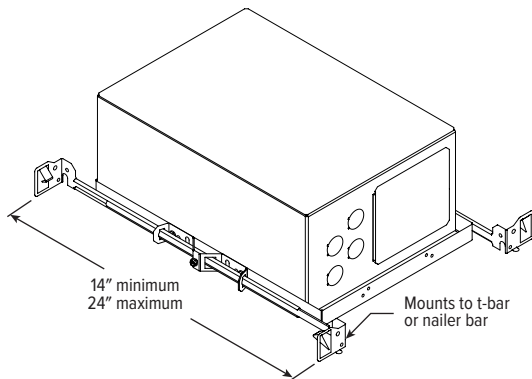
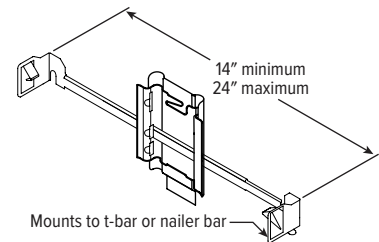

F1 with I Mounting Type

BA2 Adjustable butterfly pan bracket, heavy-duty universal bar hanger included (N Mounting Type only)

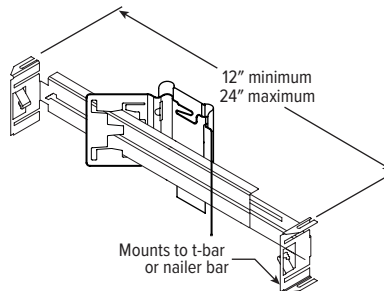

CA2 Adjustable caterpillar pan bracket, t-bar hanger included (N Mounting Type only)

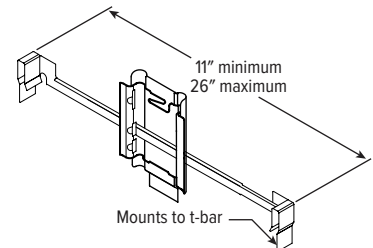

NODE CONNECTION DETAILS

Includes 24" cable with 4-position mating connector for Platformatics POE-LN2 node. See node spec sheet for details: platformatics.com/product/poe-ln2

